

IAG X-Brace Tailgate Hinge Reinforcement for 21+ Ford Bronco w/Sasquatch Package



IAG-BDY-F3192 IAG X-Brace Tailgate Hinge Reinforcement for 21+ Bronco w/ Sasquatch

(Not Raptor)

Part# IAG-BDY-F3192

Congratulations on the purchase of your IAG X-Brace Tailgate Hinge Reinforcement (Not Raptor), and thank you for choosing IAG Performance. These instructions are intended for users with basic mechanical skills. Professional installation is not required. The average installation time is approximately 60-90 minutes. A second person to help with lifting is recommended for easiest installation.

Video instructions can be found at the link below.

<https://youtu.be/wnyyXdqvjks>

Step 1/72



IAG-BDY-F3192 IAG X-Brace Tailgate Hinge Reinforcement for 21+ Bronco w/ Sasquatch (Not Raptor)

Part# IAG-ACC-F3192

Tools Required For Installation:

10MM Socket, 13MM Socket, TP45 Torx, 6MM Allen, Ratcheting Wrench, Phillips Screwdriver

Optional: Plastic Body Panel Tool

Step 2/72

Step 3/72

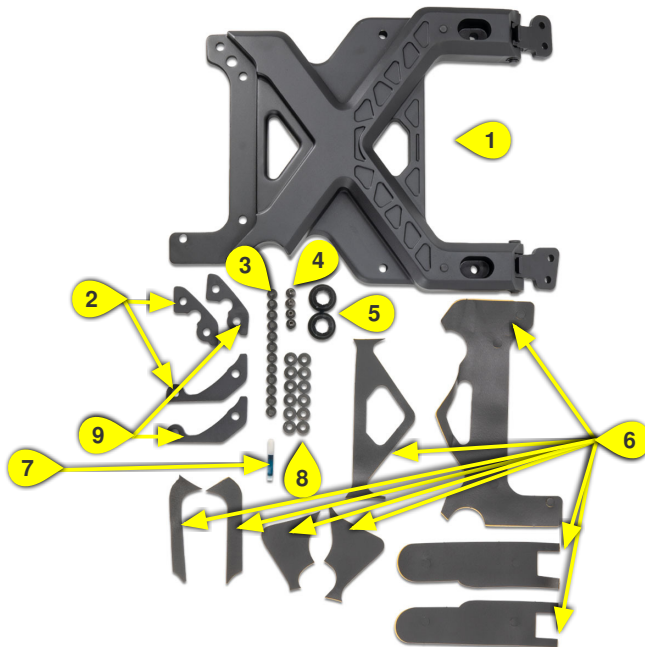

Numbered annotations (9)

- 1 X-Brace Tailgate Reinforcement
- 2 Thin spare tire mount spacers
- 3 13mm Bolts
- 4 6mm Allen Head Bolts
- 5 Spare tire support bushings
- 6 Adhesive foam protection for X-Brace
- 7 Loctite
- 8 Washers
- 9 Thick spare tire mount spacers

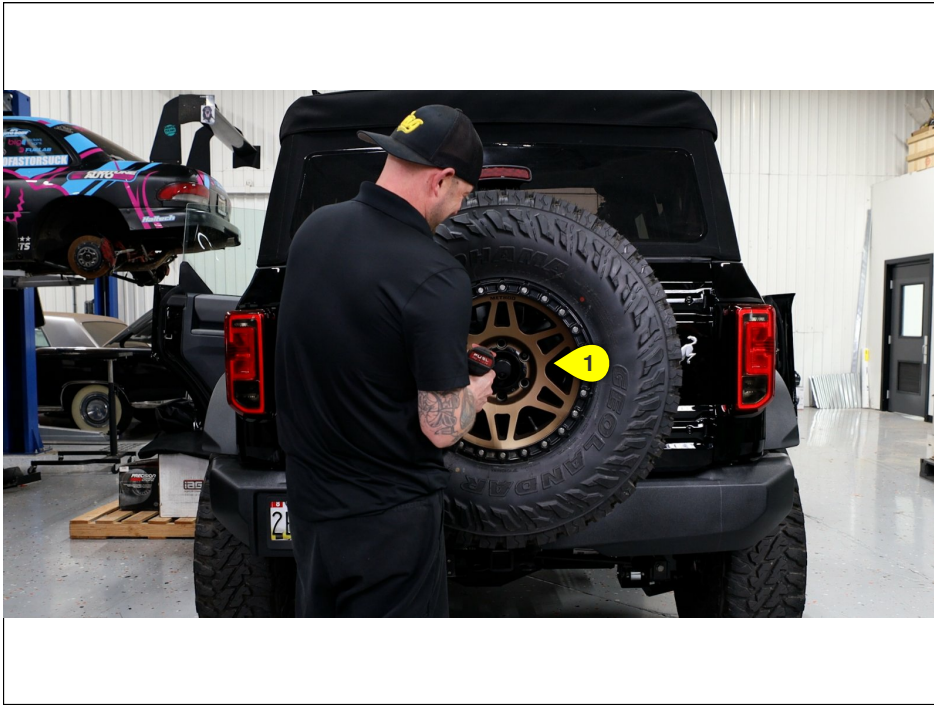

Step 4/72

Numbered annotations (1)

- 1 Unbolt the spare tire

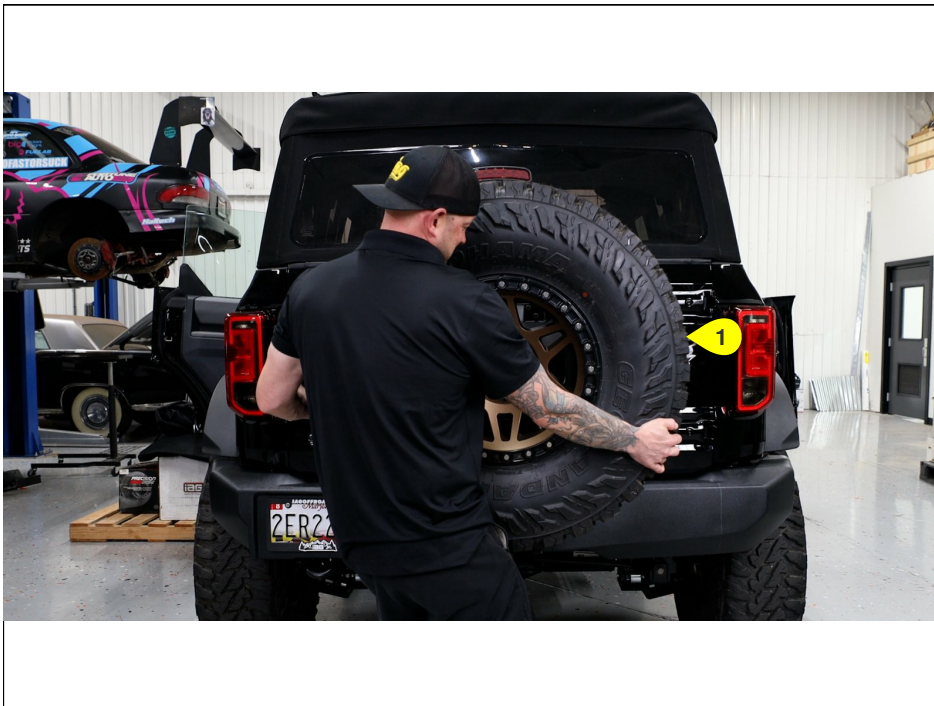

Step 5/72

Numbered annotations (1)

- 1 Remove the spare tire



Step 6/72

Numbered annotations (1)

- 1 Fold down both rear seats

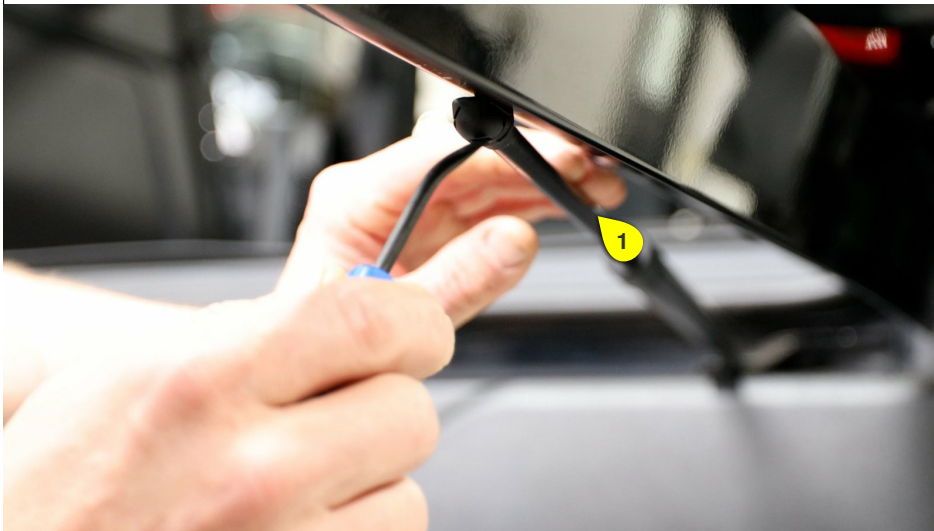

Step 7/72

Numbered annotations (1)

- 1 Using a pry tool or flat head screwdriver, remove the tailgate strut

Step 8/72

Numbered annotations (1)

- 1 Remove strut



Step 9/72

Numbered annotations (1)

- 1 Remove the tailgate access panel



Step 10/72

Numbered annotations (1)

- 1 Unclip two (2) harnesses from the tail gate



Step 11/72

Numbered annotations (1)

- 1 Disconnected harnesses



Step 12/72

Numbered annotations (1)

- 1 Unclip the tailgate wiring harness seal



Step 13/72

Numbered annotations (1)

- 1 Remove tailgate wiring harness seal and pull it through the tailgate



Step 14/72

Numbered annotations (1)

- 1 Tailgate with wiring harness removed



Step 15/72

Numbered annotations (1)

- 1 Using a 13mm wrench or socket, remove the eight bolts securing the spare tire mount

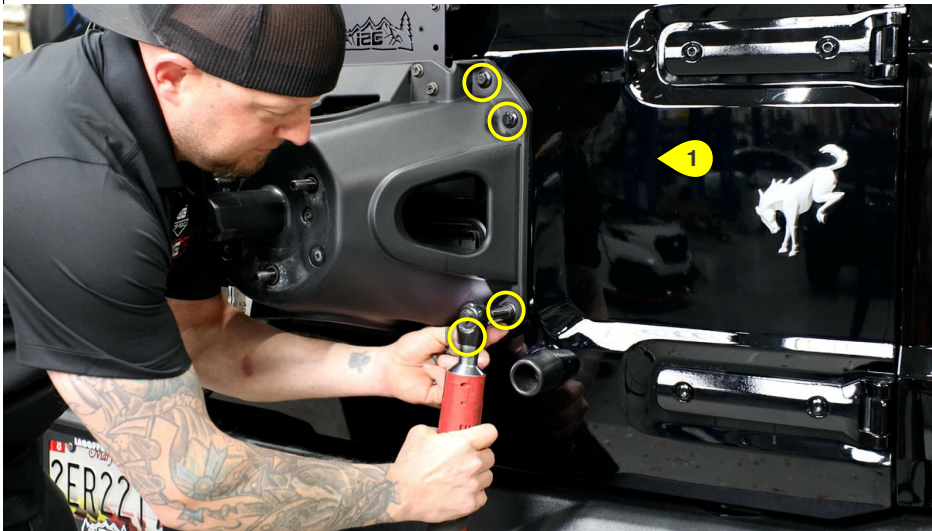

Step 16/72

Numbered annotations (1)

- 1 Remove spare tire mount

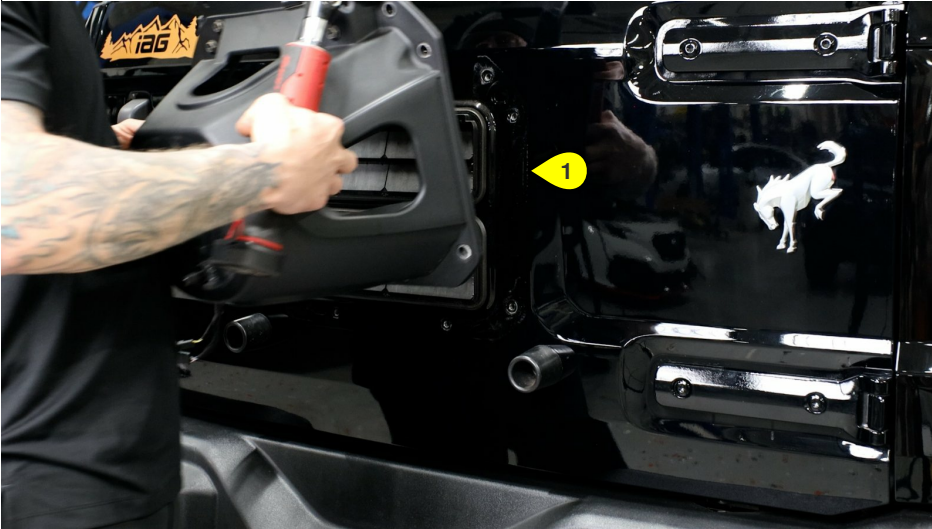

Step 17/72

Numbered annotations (1)

- 1 Using your TP45 Torx remove top hinge bolts



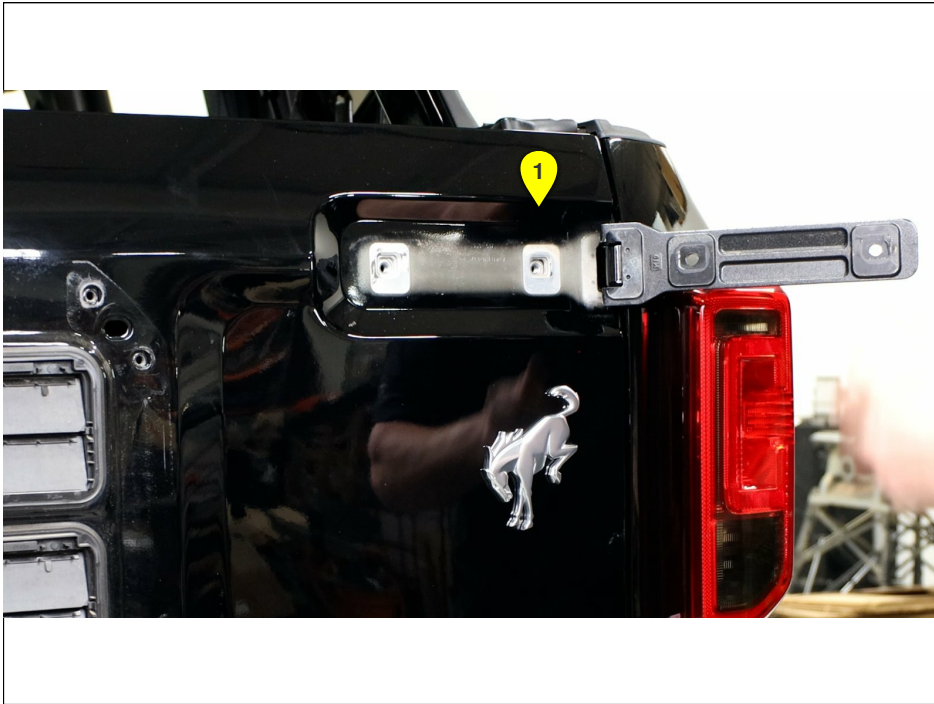

Step 18/72

Numbered annotations (1)

- 1 Once the bolts are removed open the hinge

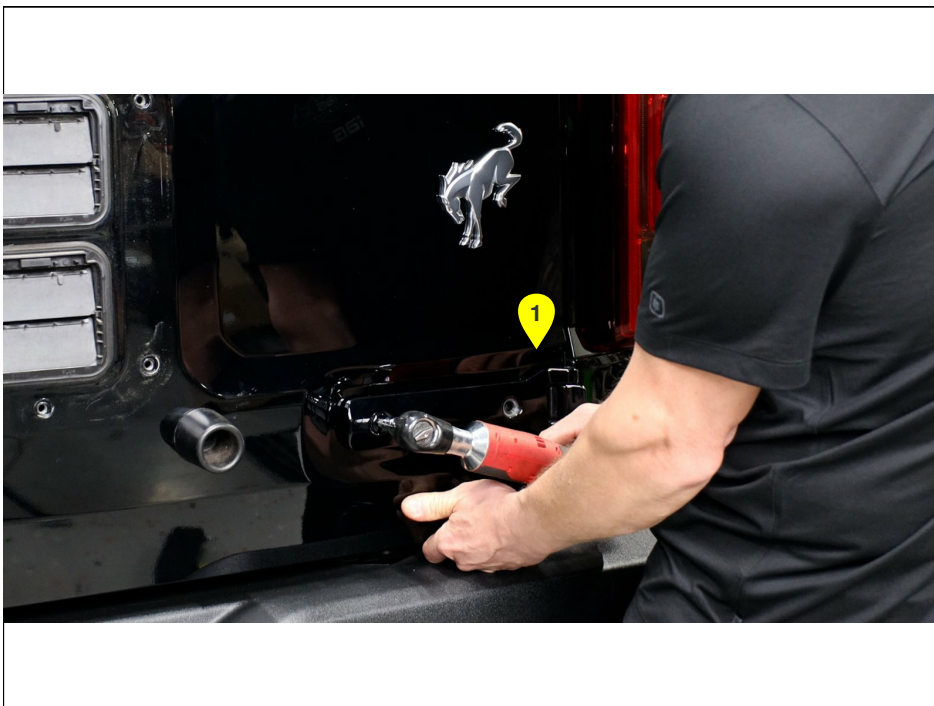

Step 19/72

Numbered annotations (1)

- 1 Remove lower two (2) hinge bolts



Step 20/72

Numbered annotations (1)

- 1 Open the hinge

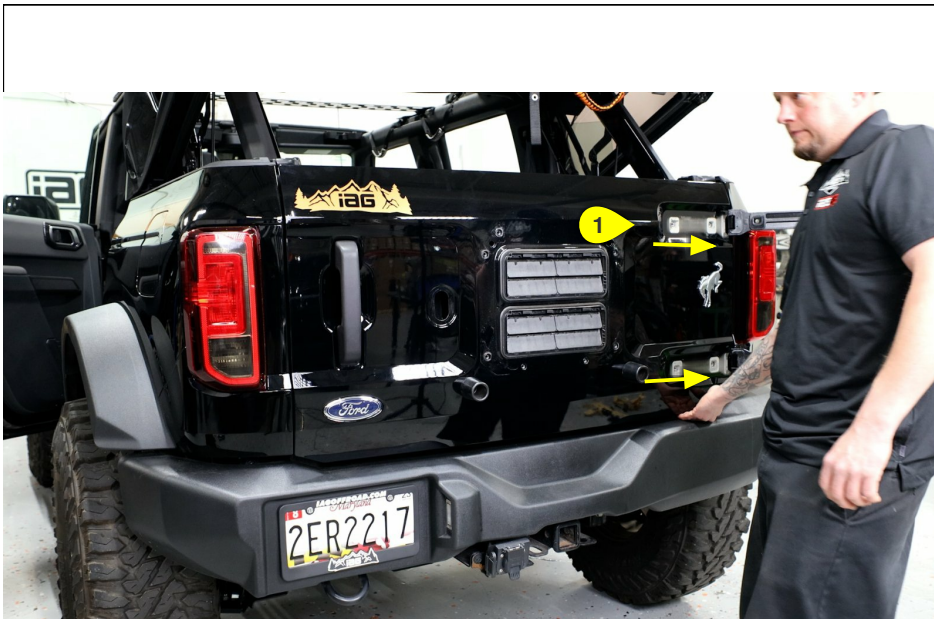

Step 21/72

Numbered annotations (1)

- 1 Open both hinges keeping the latch shut

Step 22/72

Numbered annotations (1)

- 1 With one hand supporting the tailgate. Unlatch the tailgate and slightly move it away from the rear of the Bronco



Step 23/72

Numbered annotations (1)

- 1 Place your tailgate, latch end first and handle side up into the trunk area of your bronco

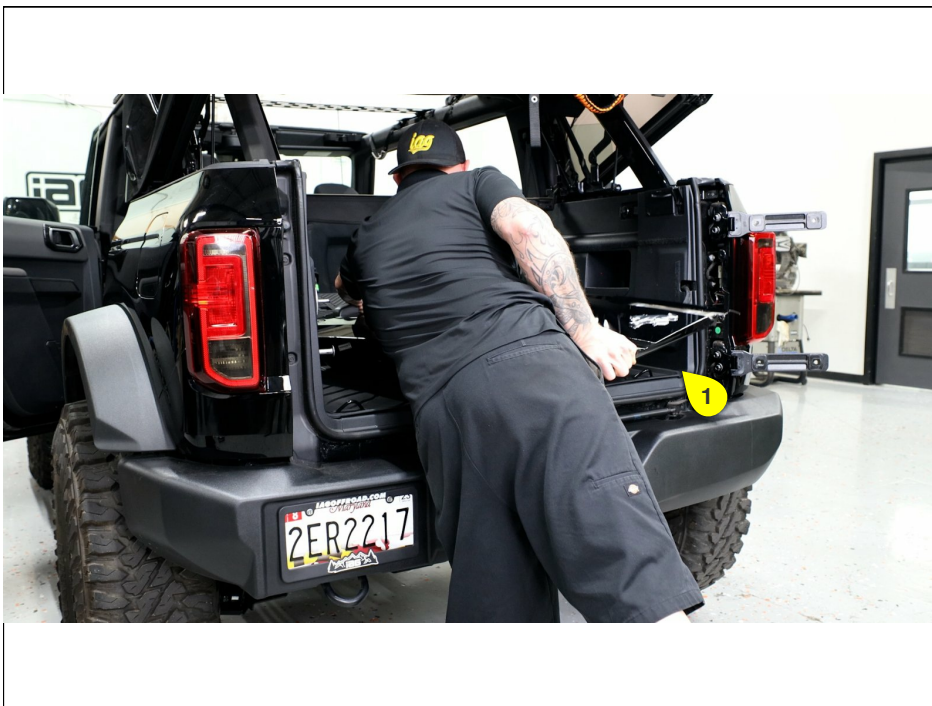



Step 24/72

Numbered annotations (1)

- 1 Place a box or something you are comfortable with under the tailgate for support to keep the wiring harness from being so tight



Step 25/72

Numbered annotations (1)

- 1 Using a Phillips Screwdriver remove the four (4) push pins

Step 26/72



Step 27/72



Numbered annotations (1)

- 1 Using a 10mm wrench or socket remove the top bolt holding the hinge trim panel

Step 28/72



Numbered annotations (1)

- 1 Using a 10mm wrench or socket remove the bottom bolt holding the hinge trim panel

Step 29/72





Step 30/72

Numbered annotations (1)

- 1 Remove hinge trim panel

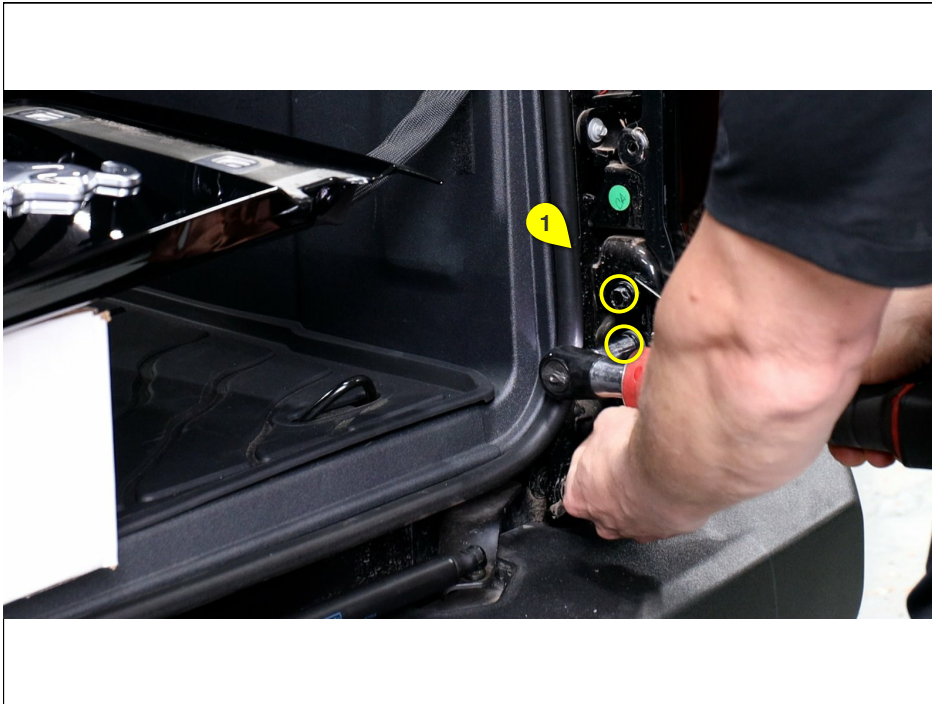

Step 31/72

Numbered annotations (1)

- 1 Using 13mm Socket or wrench, remove the two (2) hinge bolts

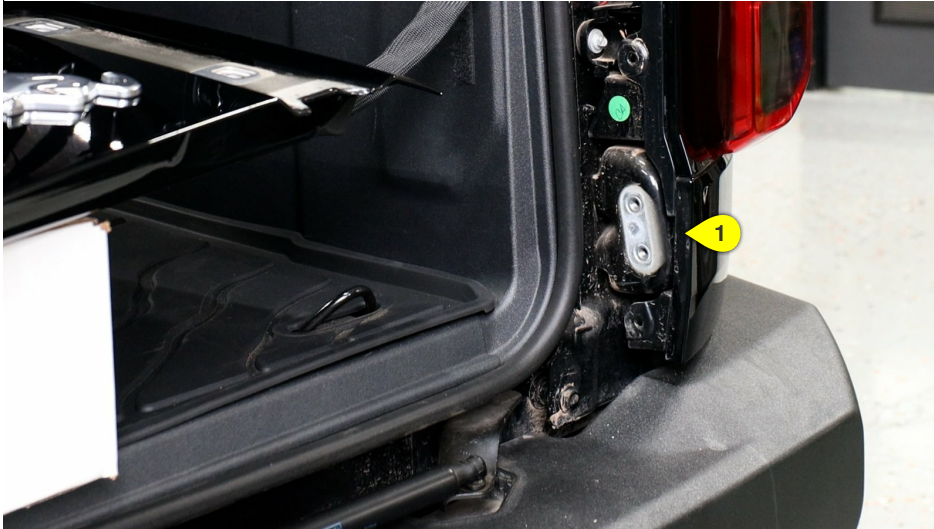

Step 32/72

Numbered annotations (1)

- 1 Remove the hinge



Step 33/72

Numbered annotations (1)

- 1 Using 13mm Socket or wrench, remove the two (2) hinge bolts

Step 34/72



Numbered annotations (1)

- 1 Remove the hinge

Step 35/72



Numbered annotations (2)

- 1 Install the provided padding on to the backside of the X-Brace
- 2 Refer to the digram for the proper layout

Step 36/72



Step 37/72



Numbered annotations (1)

- 1 Apply Loctite onto the provided four (4) 6mm Allen Head hinge bolts



Step 38/72

Numbered annotations (1)

- 1 Install X-Brace to the vehicle using the four (4) provided 6mm Allen bolts



Step 39/72

Numbered annotations (1)

- 1 Using the 6mm allen tighten the hinge bolts to the vehicle

Step 40/72

Numbered annotations (1)

- 1 Using one hand to support the end of the tailgate Use the other hand on the latch and carefully move the tailgate from the trunk of the vehicle



Step 41/72

Numbered annotations (1)

- 1 Reinstall the tailgate making sure it latches back into position



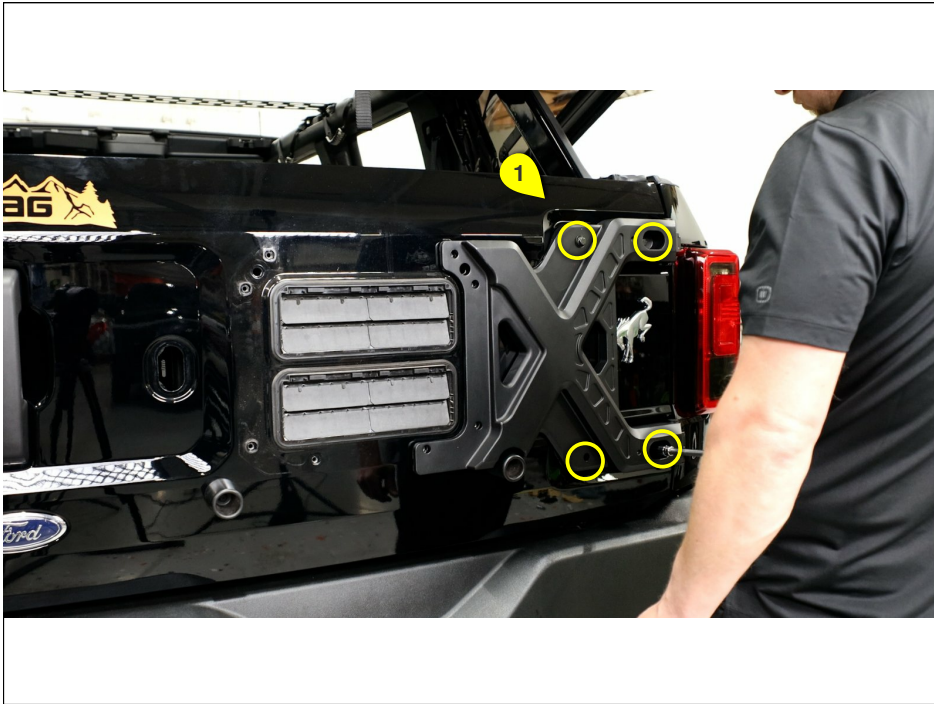

Step 42/72

Numbered annotations (1)

- 1 Install the X-Brace back to the tailgate using provided four (4) 13mm hinge bolts



Step 43/72

Numbered annotations (1)

- 1 Using 13mm Socket, snug fit the bolts on to the X-Brace



Step 44/72

Numbered annotations (1)

- 1 Once you are satisfied with the fitment of your X-Brace, using a 13mm Socket, tighten the bolts on to the X-Brace

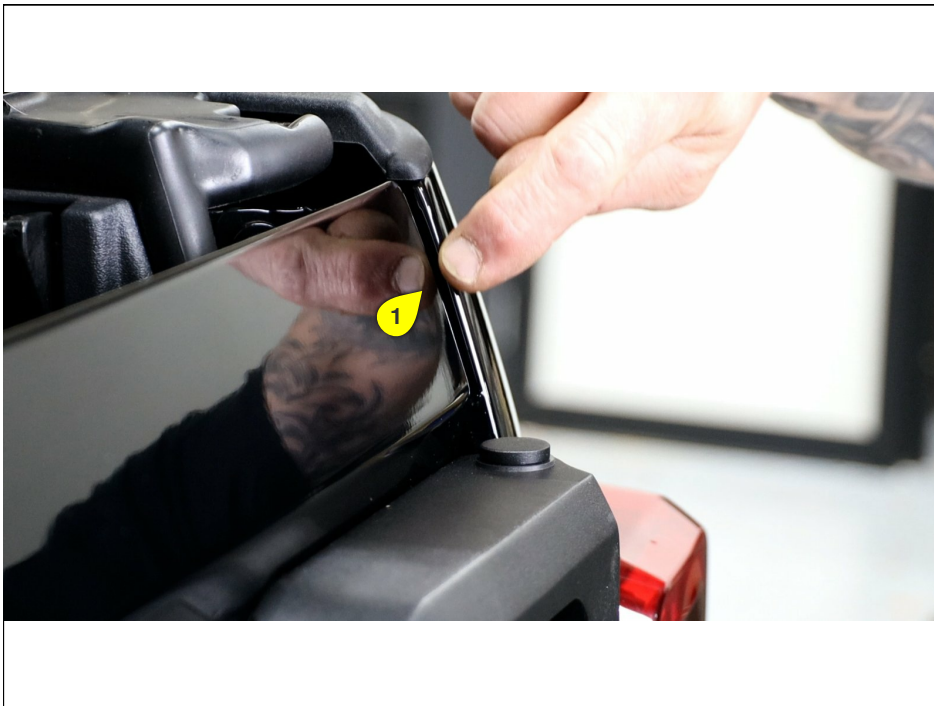

Step 45/72

Numbered annotations (1)

- 1 Check the alignment and spacing between the tailgate and body corner, this is shown with offset in towards the front

Step 46/72

Numbered annotations (1)

- 1 Use the inner hinge bolts to adjust the tailgate in or out from the back of the vehicle



Step 47/72

Numbered annotations (1)

- 1 Correct alignment



Step 48/72



Numbered annotations (1)

- 1 Once properly aligned, tighten all hinge bolts using 13mm socket and wrench.

Step 49/72



Numbered annotations (1)

- 1 Reinstall the hinge trim panel



Step 50/72

Numbered annotations (1)

- 1 Reinstall four (4) push-pins



Step 51/72

Numbered annotations (1)

- 1 Using a socket or wrench reinstall two (2) 10mm trim panel bolts

Step 52/72

Numbered annotations (1)

- 1 Reinstall your tailgate strut by pushing it back onto the ball mount



Step 53/72

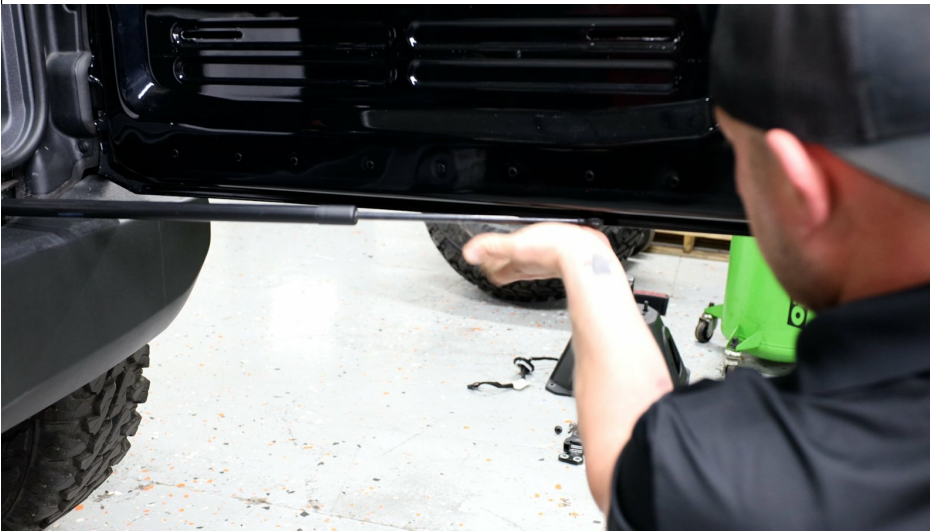

Step 54/72



Step 55/72

Numbered annotations (1)

- 1 Install padding onto two of the X-Brace spacers (Thick Spacers)

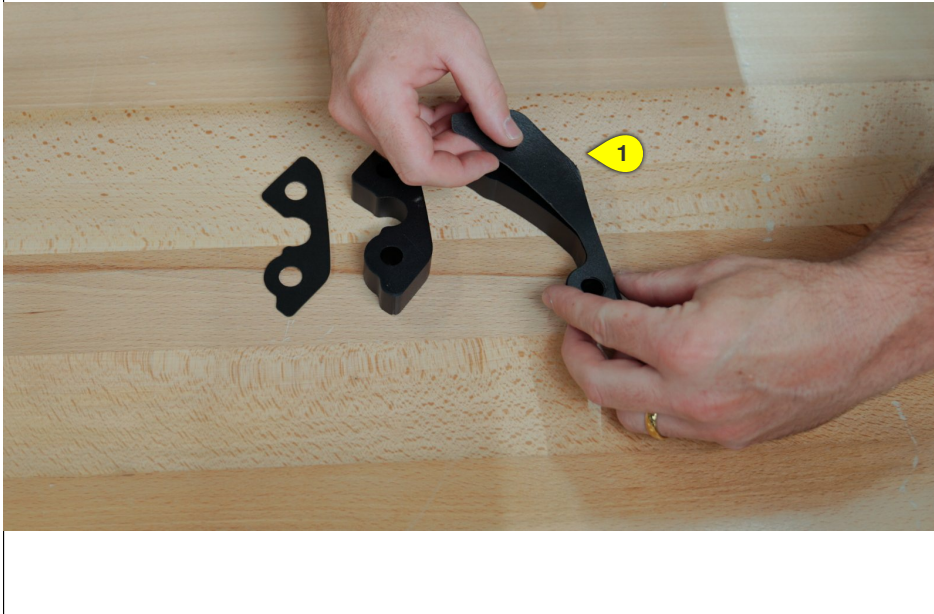

Step 56/72

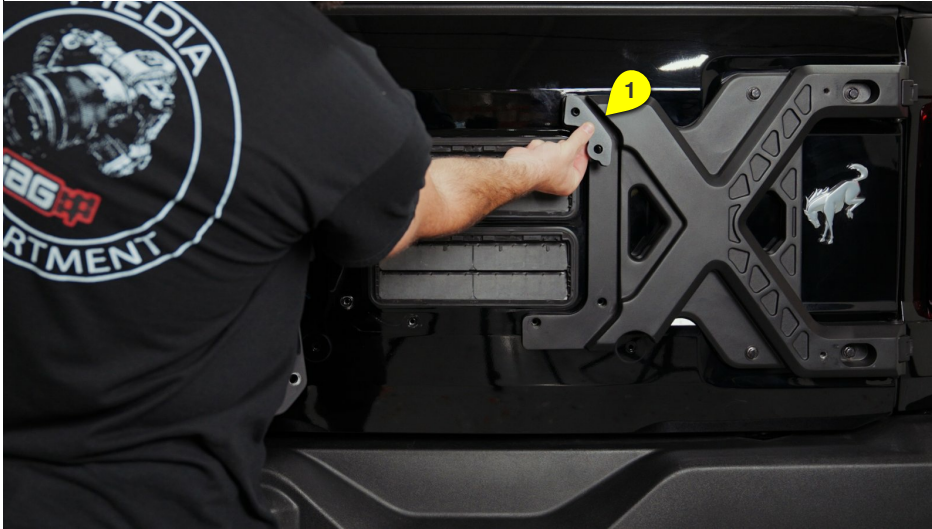

Numbered annotations (1)

- 1 The thinner spacer will be installed here.

Step 57/72



Numbered annotations (1)

- 1 When reinstalling the spare tire mount be sure to pass the wires harness side first and reinstall the tailgate seal

Step 58/72

Numbered annotations (1)

- 1 This thinner spacer will be installed here.



Step 59/72





Step 60/72

Numbered annotations (1)

- 1 Install spacers behind tire carrier, align and install and hand tighten the four (4) passenger side 13mm bolts



Step 61/72

Numbered annotations (1)

- 1 This thicker spacer with padding is installed here

Step 62/72



Step 63/72

Numbered annotations (1)

- 1 Install this thicker spacer with padding here.



Step 64/72



Step 65/72

Numbered annotations (1)

- 1 Install and hand tighten the (4) 13mm bolts

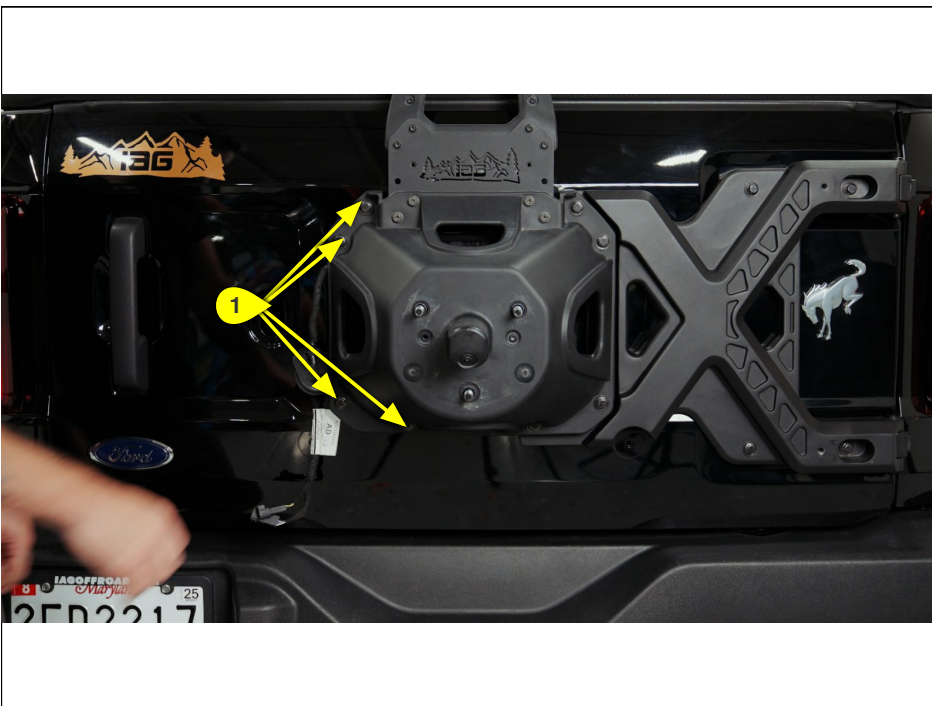

Step 66/72

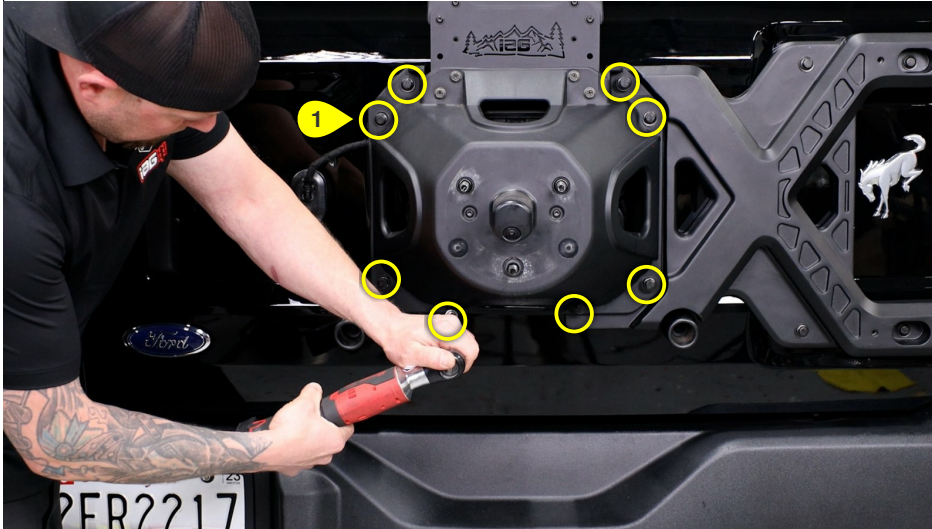

Numbered annotations (1)

- 1 Using a 13mm socket or wrench tighten the eight (8) bolts for the spare tire mount

Step 67/72



Numbered annotations (1)

- 1 Reinstall two (2) harnesses

Step 68/72

Numbered annotations (1)

- 1 Reinstall the tailgate access by pressing it back into position



Step 69/72

Numbered annotations (1)

- 1 Insert spare tire bushing into current bushing





Step 70/72

Numbered annotations (1)

- 1 Remount your spare tire

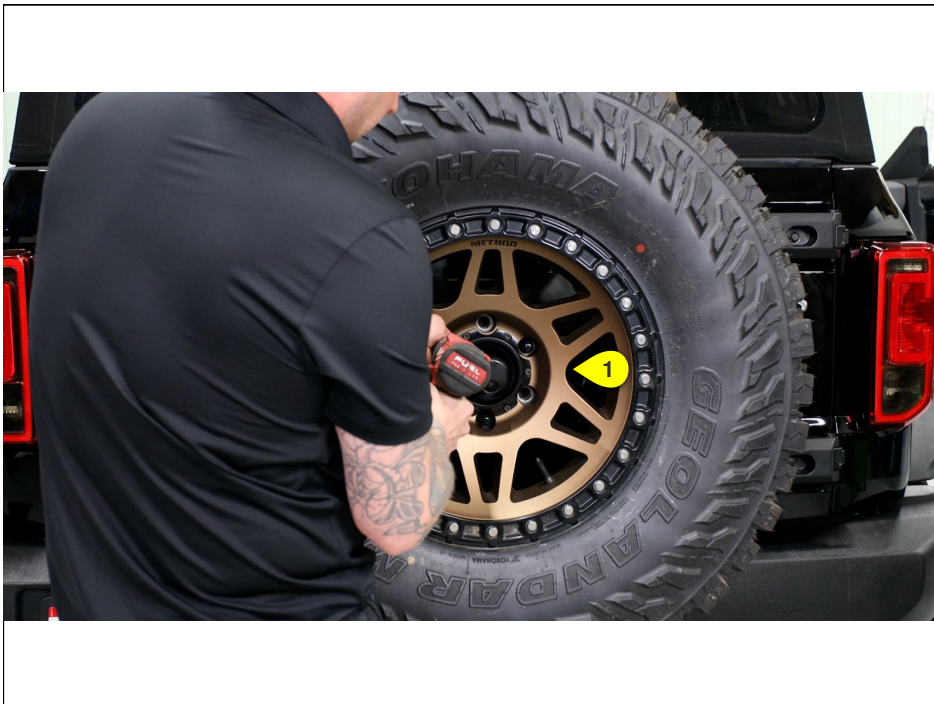

Step 71/72

Numbered annotations (1)

- 1 Tighten the lugs accordingly

Step 72/72

Numbered annotations (1)

- 1 You have completed the install of your X-Brace Tailgate Hinge Reinforcement for the 21+ Bronco

Enjoy

